

Technical drawing • Technische tekening • Dessin technique

Article 640.012

Artikel 640.013

Article

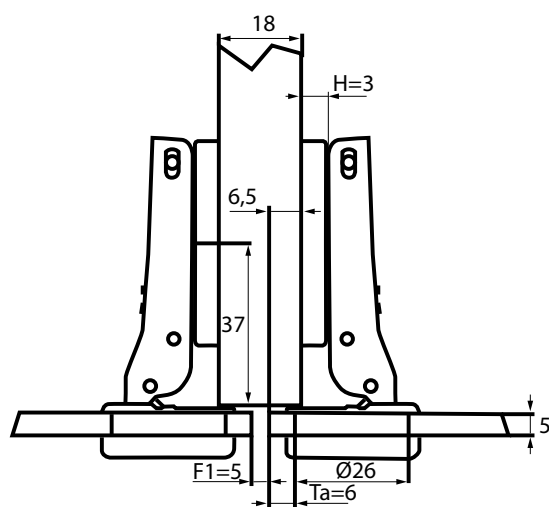

Top-afstand Distance Ta	Aanslag Butée
5,5 mm	6,0 mm
6,0 mm	6,5 mm
6,5 mm	7,0 mm