

CHARNIÈRE 1027

Charnière pour vantail à fil avec joints en polyéthylène.

Tiges, roue, ressorts et tiges filetées en inox.

- Matériau: métal moulé sous pression
- Dimensions plaque: H 27 x L 58 mm

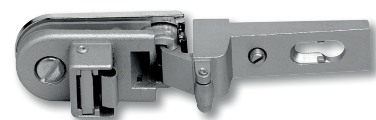
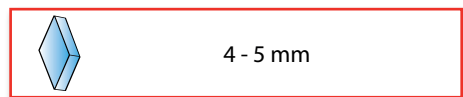
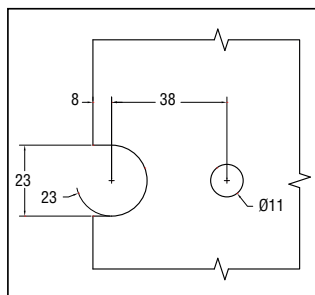
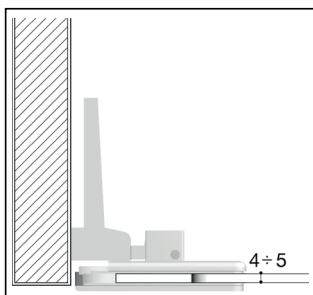

PINCES DE
FIXATION

ÉTAGÈRES

FIXATION
DE MIROIR

COLLAGE UV

PORTES ET VITRES
COULISSANTES

SÉPARATIONS
COMPTOIRS - GUICHETS

MOBILIER

MIROIRS
PANORAMIQUES

NETTOYAGE

Code article	Description	uv
429.CER1027.14	Chromé brillant	1 pièce
429.CER1027.101	Nickel brossé	1 pièce

CHARNIÈRE 1028

Charnière pour vantail à butée avec joints en polyéthylène.

Tiges, roue, ressorts et tiges filetées en inox.

- Matériau: métal moulé sous pression
- Dimensions plaque: H 27 x L 55 mm
- Débordement: au max. 8 mm

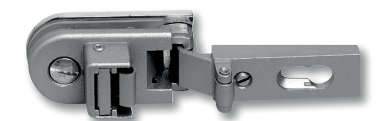
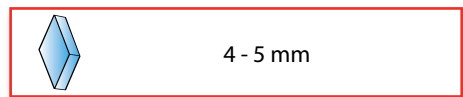
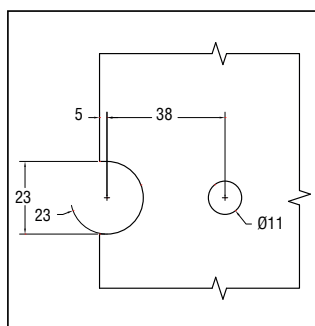
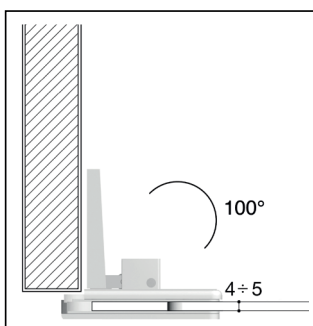

Code article	Description	uv
429.CER1028.14	Chromé brillant	1 pièce
429.CER1028.101	Nickel brossé	1 pièce