

Technical drawing • Technische tekening • Dessin technique

Article 640.205

Artikel

Article

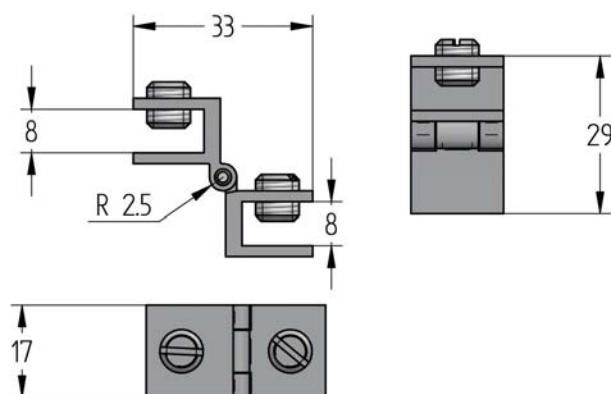

www.pieterman-glastechniek.com • www.pieterman-steentechniek.com

Nederland

Industrieweg 28
3133EE Vlaardingen
T +31 10 445 10 60
F +31 10 435 34 81
info@pgv-nl.com

België

Schemkensstraat 1
3583 Paal-Beringen
T +32 11 42 17 75
F +32 11 42 07 92
info@pgv-be.com